

# LabVIEW-NI ELVIS II based Speed Control of DC Motor

S.Muruganandhan<sup>#1</sup>, G.Jayabaskaran<sup>\*2</sup>, P.Bharathi<sup>#3</sup>

<sup>#</sup>Department of Electrical and Electronics Engineering, Kalaignar Karunanidhi Institute of Technology, Kannampalayam post, Coimbatore-641402, Tamilnadu, India.

<sup>\*</sup> Kalaignar Karunanidhi Institute of Technology, Kannampalayam post, Coimbatore-641402, Tamilnadu, India

**Abstract**—The intention of this paper is providing an efficient and simple method for control speed of DC motor using pulse width modulation technique. The modulation of pulse is obtained from the LabVIEW-NI ELVIS combination. There are several methods for controlling the speed of DC motors. One simple method is to add series resistance using a rheostat. As considerable power is consumed in the rheostat, this method is not economical. Another method is to use a series switch that can be closed or opened rapidly. This type of control is termed as chopper control. The PWM based chopper circuit smoothly controls the speed of general-purpose DC motors. We used the LabVIEW software and NI ELVIS II DAQ card to control the duty cycle precisely.

**Keywords**— DC Motor, Speed Control, PWM, LabVIEW, NI ELVIS, DAQ.

## I. INTRODUCTION

Nowadays, AC power becomes popular and advantageous because of easy generation, transmission with less loss to long distances due to stepping up voltage and stepping down the voltage to a desired level. In Industries 70% of the motors and drives used are induction motors, hence ac motors in general means induction motors. Induction motors were preferred in industries due to the advantages of its rugged construction, less maintenance and can be operated in explosive atmospheres also. Therefore, Induction motors ruled out all the motors in industries in every application<sup>[1]</sup>. However, DC motors were still used for certain applications where induction motors cannot fulfil the need. So, dc motors have its own significance in industries. This is because some special characteristics they possess. We used the PMDC motor for this study.

Commonly used simulation software's are Pspice, Protel, and Matlab.

LabVIEW, compared with other computer softwares, there is a particularly important difference: other computer softwares are created based upon the language along the text lines of code, LabVIEW graphical programming language - G language. The resulting program is block diagram form. LabVIEW is also a perfect simulation, debugging tools, such as setting breakpoints, single step and so on. With LabVIEW's dynamic continuous tracking mode, the process of data and changes can be continuously and dynamically observed, so it

is more convenient and more effective than any other language development environment. The actual motor parameters can be modified directly, which will greatly facilitate the simulation.

## II. SPEED CONTROL OF DC MOTOR

### A. Introduction to motor

We used the PMDC motor for this study. Permanent-magnet types have some performance advantages over direct-current, excited, synchronous types, and have become predominant in fractional horsepower applications. They are smaller, lighter, more efficient and reliable than other singly fed electric machines.

Originally, all large industrial DC motors used wound field or rotor magnets. Permanent magnets have traditionally only been useful on small motors because it was difficult to find a material capable of retaining a high-strength field. Only recently have advances in materials technology allowed the creation of high-intensity permanent magnets, such as neodymium magnets, allowing the development of compact, high-power motors without the extra real-estate of field coils and excitation means. However, as this high performance permanent magnets become more applied in electric motor or generator systems, other problems are realized.

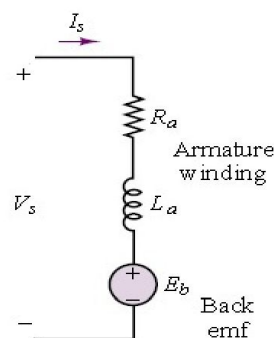

Figure.1 Circuit model for PM Motor

B. Speed Control

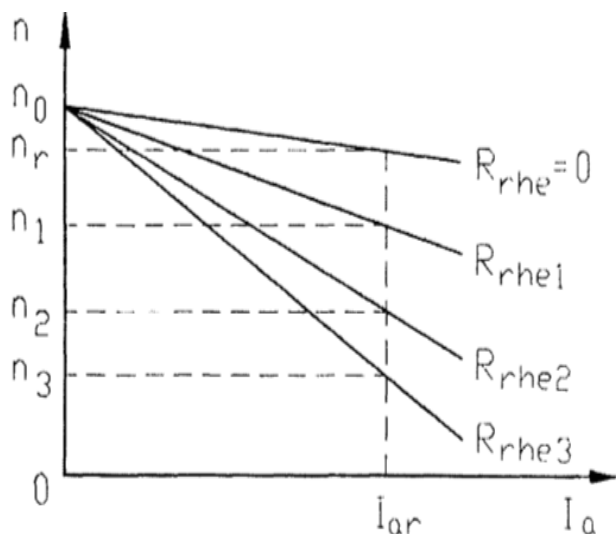

Figure 2 Speed-Armature current curve of PM DC motor

$$n = \frac{1}{c_E \phi_g} [V - I_a (\sum R_a + R_{rhe}) - \Delta V_{br}] \tag{1}$$

The above equation tells that the speed of a d.c. motor can be controlled by changing the supply mains voltage  $V$ <sup>[2]</sup>. The armature-circuit resistance

$$\left( \sum R_a + R_{rhe} \right) \tag{2}$$

Where,  $R_{rhe}$  is the resistance of the armature rheostat. The air gap (field)  $\phi_g$  flux

From this it is possible to obtain the steady-state speed  $n$  of a PM d.c. commutator motor as a function of  $T_d$  for a given  $V$ , i.e

$$n = \frac{1}{k_E} (V - \Delta V_{br}) - \frac{\sum R_a + R_{rl}}{k_E k_T} T_d \tag{3}$$

The existing methods for controlling the DC Motor are

1. Armature terminal voltage control
2. Armature rheostat speed control
3. Shunt field control
4. Chopper variable speed control

In this, paper concentrated on the chopper variable speed control via TPWM from LabVIEW. The pulse-width modulation technique is the commonly used method to control

the motor. So, we fabricated the chopper circuit to interface the motor and DAQ device.

III. PULSE WIDTH MODULATION

A. Introduction to PWM

Pulse-width modulation (PWM) or pulse-duration modulation (PDM) is a modulation technique that conforms the width of the pulse, formally the pulse duration, based on modulator signal information. Although this modulation technique can be used to encode information for transmission, its main use is to allow the control of the power supplied to electrical devices, especially to inertial loads such as motors. The average value of voltage (and current) fed to the load is controlled by turning the switch between supply and load on and off at a fast pace. The longer the switch is on compared to the off periods, the higher the power supplied to the load is.

B. Trapezoidal Pulse width modulation

In this method, the switching pattern design should generally satisfy two conditions: (a) The dc current  $I_d$  should be continuous, and (b) the inverter PWM current  $s_h$  should be defined. The two conditions can be translated into a switching con-strain: At any instant of time (excluding commutation intervals), there are only two switches conducting, one in the top, half of the bridge and the other in the bottom half. With only one switch turned on, the continuity of the dc current is lost. A very high voltage will be induced by the dc choke, causing damage to the switching de-vices. If more than two devices are on simultaneously, the PWM current  $I_w$  is not defined by the switching pattern. For instance, with S1, S2 and S3conducting at the same time, the currents in S1and S3, which are the PWM currents in the inverter phases A and B, are load dependent although the sum of two currents equal to  $I_d$ .

Figure.3 shows the principle of trapezoidal pulse width modulation (TPWM), where  $V_m$  is a trapezoidal modulating wave, and  $V_{cr}$  is a triangular carrier wave. The amplitude modulation index is defined by  $m_a$

$$m_a = \frac{V_m}{V_r} \tag{4}$$

Where  $V_m$  and  $V_{cr}$  are the peak values of the modulating and carrier waves, respectively. Similar to the carrier based PWM schemes for voltage source inverters, the gate signal  $V_{g1}$  for switch S1 is generated by comparing  $V_m$  with  $V_{cr}$ . However, the trapezoidal modulation does not generate gatings in the center interval of the positive half-cycle or in the negative half-cycle of the inverter fundamental frequency. Such an arrangement leads to the satisfaction of the switching constraint for the CSI. It can be observed from the gate signals

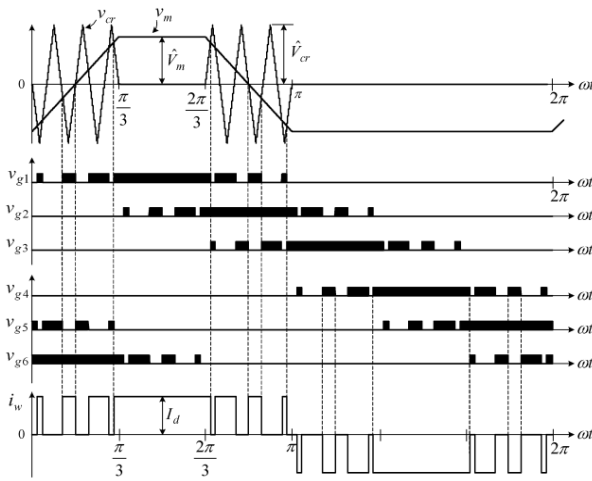

Figure 3. Trapezoidal Pulse width Modulation

that only two GCTs conduct at any time, resulting in a defined  $I_w$ . The magnitude of  $i_w$  is set by the dc current  $I_d$ .

#### IV. LABVIEW SIMULATION AND DATA ACQUISITION

##### A. Introduction to LabVIEW

LabVIEW (short for Laboratory Virtual Instrumentation Engineering Workbench) is a system design platform and development environment for a visual programming language from National Instruments. The graphical approach also allows non-programmers to build programs by dragging and dropping virtual representations of lab equipment with which they are already familiar. The LabVIEW programming environment, with the included examples and documentation, makes it simple to create small applications<sup>[5]</sup>. This is a benefit of one side, but there is also a certain danger of underestimating the expertise needed for high-quality G programming.

##### B. Data Acquisition

Data acquisition (DAQ) is the process of measuring an electrical or physical phenomenon such as voltage, current, temperature, pressure, or sound with a computer. A DAQ system consists of sensors, DAQ measurement hardware, and

a computer with programmable software. Compared to traditional measurement systems, PC-based DAQ systems exploit the processing power, productivity, display, and connectivity capabilities of industry-standard computers providing a more powerful, flexible, and cost-effective measurement solution<sup>[4]</sup>.

##### C. LabVIEW Program for PWM

PWM signals can be generated as a digital signal, using counters or digital output line(s), or as an analog signal, using, for instance, an arbitrary waveform generator or an RF signal generator. Several National Instruments multifunction data acquisition (DAQ) devices are capable of producing PWM signals. The LabVIEW graphical development environment, combined with NI-DAQmx, gives you the tools needed to easily construct applications using counters to generate PWM signals. The first step to create a PWM signal is to produce a simple digital pulse train. We will measure the PWM signal on the oscilloscope on the NI ELVISmx Instrument Launcher. Finally, we use the output to drive a PMDC motor.

1. In this program, Output, a pulse width modulated signal with varying duty cycle has been created. As per the block diagram, first we have to create the physical channels to bring out the signal. We have to Analog ports in NI ELVIS II (AO0, AO1)<sup>[6]</sup>. As per the conflict matrix, we can use both analog ports simultaneously. However, we have met a problem for using both ports. For this, all the blocks are available in Data-Acquisition palette. The maximum voltage range of this analog port is 10v. We can also use a Digital port for this operation, but the buffer size should be increased.

2. And then to prohibit the automatic regeneration of data while writing operation, we have to configure the task. The only different samples will be obtained.

3. Then the next function called the DAQmx (Sample Clock) VI to set the sample clock rate. Additionally, set the sample mode to Continuous. It sets the source of the Sample Clock, the rate of the Sample Clock, and the number of samples to acquire or generate. And read the actual sample clock rate (eventually coerced depending upon the hardware used).

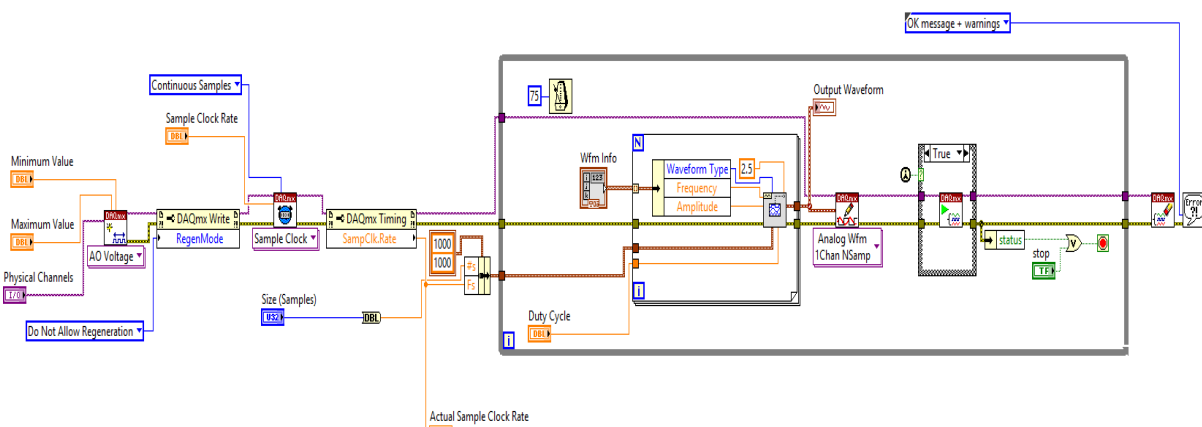

Figure 4. LabVIEW Block diagram for PWM

Actually, it reads the properties of reference.

5. Set the duty cycle of the motor. And compute the desired waveform using the buffer size and update rate. This VI keeps track of the phase of the waveform to ensure that the generated signal is continuous. And Write the waveform to the output buffer. And call the start VI with for loop. The while loop will run continuously until the user presses the stop button. Every iteration computes and writes a new waveform to the buffer. Call the clear task VI to clear the task.9. Use the popup dialog box to display an error or warning if any.

### V. RESULTS AND ANALYSIS

The LabVIEW front panel graph shows the simulation of the program.

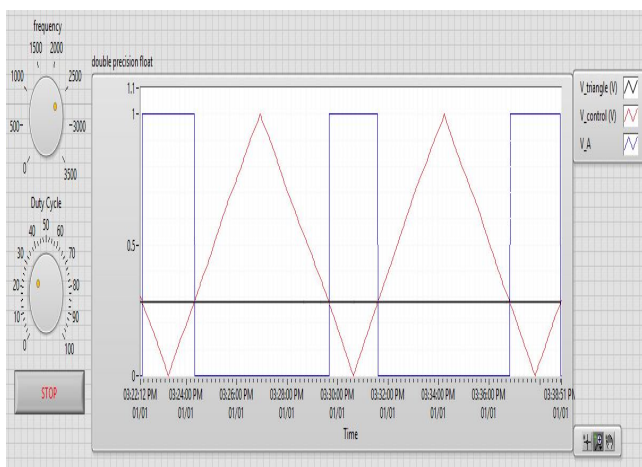

Figure 5. LabVIEW Front Panel

The different readings are taken for the different range of duty cycles. Then the graphs are plotted from the data.

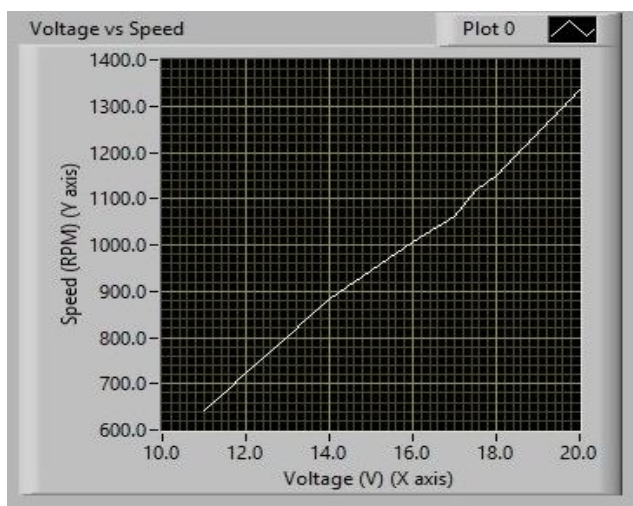

Figure 6. Voltage vs Speed characteristics curve

Figure 7 displays voltage vs Speed characteristic's curve

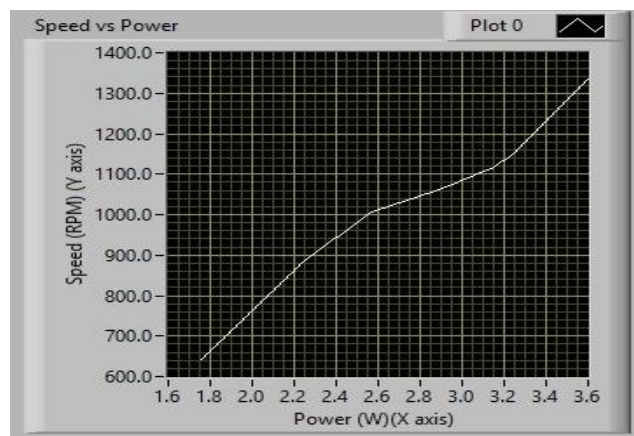

Figure 7. Power vs Speed characteristics curve

### VI. CONCLUSIONS

The analysis with experimental results shows that motor control established with LabVIEW can effectively control the speed of the motor. Data-Acquisition Toolbox is used to convert the virtual signals to physical signal. By means of using this simulation, we can test the motor speed for different voltages without any power loss. LabVIEW is proven to be an excellent tool for electrical simulation.

### VII. ACKNOWLEDGEMENT

We would like to acknowledge and extend my heartfelt gratitude to Professor S.Suresh and Lecturer V.Rajasekaran for their great efforts of supervising and leading us, to accomplish this fine work. A special thank you goes to those who contributed to this paper: N.Gunasekaran and N.Dharsiya rupha for their valuable comments and sharing their knowledge. We thank every person gave us something to light our pathway; we thank them for believing in us.

### REFERENCES

- [1] E. Levi, "Impact of iron loss on behavior of vector controlled induction machines," IEEE Trans. Ind. Appl., vol. 31, no. 6, pp. 1287–1296, Nov./Dec. 1995.
- [2] Yunqiu. Tang, Yihuang. Zhang and Yu. Fan, Dynamic Analysis of Alternating Current Machines. Beijing: China Machine Press, 2004, ch. 1
- [3] Jian. Chen, Mathematical Model and Speed Modulation System of Alternating Current Machines. Beijing: National defense industry Press, 1991, ch. 2
- [4] National Instruments Corporation. Simulation Module User Manual. April 2004 Edition. Part Number 371013A-01.
- [5] Li Qianxiang, Hu Jingtao, Simulation model of Induction motor based on LabVIEW, 2010 Third International Conference on Intelligent Networks and Intelligent Systems,